



MASSEY FERGUSON



# MF 8S SERIES

205-305 HP

A NEW ERA FOR  
STRAIGHTFORWARD  
AND DEPENDABLE TRACTORS

# MF 8S SERIES A NEW ERA

FOR STRAIGHTFORWARD, DEPENDABLE TRACTORS

Much more than just a tractor, the Massey Ferguson® 8S Series provides an enhanced operator experience. It encompasses the style of tomorrow and the uniqueness of Massey Ferguson.

The exciting new MF 8S Series begins a new era for Massey Ferguson. It is designed to be a complete farming solution, offering you a better overall experience while giving you more benefits from connectivity and precision ag technology.

We began the MF 8S Series project with a blank page. At the heart of it was the global "Voice of the Customer" study: an in-depth, one-on-one interview with operators in several countries across the globe.

Key feedback from you, the customer, underlined the need for comfort, ease of use, value for money, excellent reliability, intuitive and convenient controls, efficiency transmitting maximum power to the ground, 100% connectivity, and the ability to work with the most demanding implements.

We took that feedback and created a tractor tailored to your needs and developed to keep you operating at your best while maximizing your efficiency.

Better performance. Better connectivity. Better comfort. More ease of use. Plus a low cost of operation and an optimal return on your investment. That's what the new era of the MF 8S Series has to offer.



**MADE BY DESIGN**  
EXCLUSIVE MF PROTECT-U CONCEPT

03



**MADE FOR PRODUCTIVITY**

13



**MADE FOR PRECISION AG & CONNECTIVITY**

23



**15 MADE FOR PERFORMANCE**  
ENGINE POWER EFFICIENCY

**17 MADE FOR CONTROL**

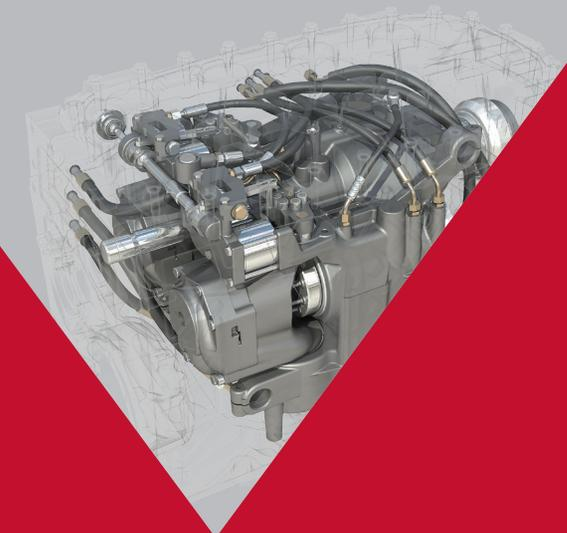

07

**MADE FOR COMFORT**  
A NEW ERA OF CAB ENVIRONMENT

- Made by Design – Exclusive MF Protect-U Concept ..... 3
- Your MF 8S Series at a Glance ..... 5
- Made for Comfort – A New Era of Cab Environment..... 7
- Made for Productivity – The Deluxe Version ..... 13
- Made for Performance – Engine Power Efficiency ..... 15
- Made for Control..... 17
- Made for Precision Ag & Connectivity ..... 23

# MADE BY DESIGN

EXCLUSIVE MF PROTECT-U DESIGN —  
ENGINE AND CAB INSTALLATION DESIGN  
PROVIDES VISIBILITY, COMFORT, EFFICIENCY  
AND ULTIMATE PERFORMANCE

The beauty of the MF Protect-U design, with a 9.4-inch (24 cm) gap between the engine and the cab, is what makes this tractor so unique. It protects you while giving you ultimate front visibility and comfort. Having the engine fully encapsulated and isolated from the cab also reduces noise and vibration, making it one of the quietest cabs on the market. It also contributes to heat insulation for the cab while improving engine cooling capacity and efficiency, maximizing uptime. The cab, together with the narrow profile hood and the inclined windshield bending toward the front, offers ultimate visibility, space and comfort.

## THE PROTECT-U DESIGN

The encapsulated engine is always getting fresh air, which contributes to better engine performance through improved cooling capacities.

MASSEY FERGUSON  
8S.265



“The style of tomorrow.  
The uniqueness of  
Massey Ferguson.”

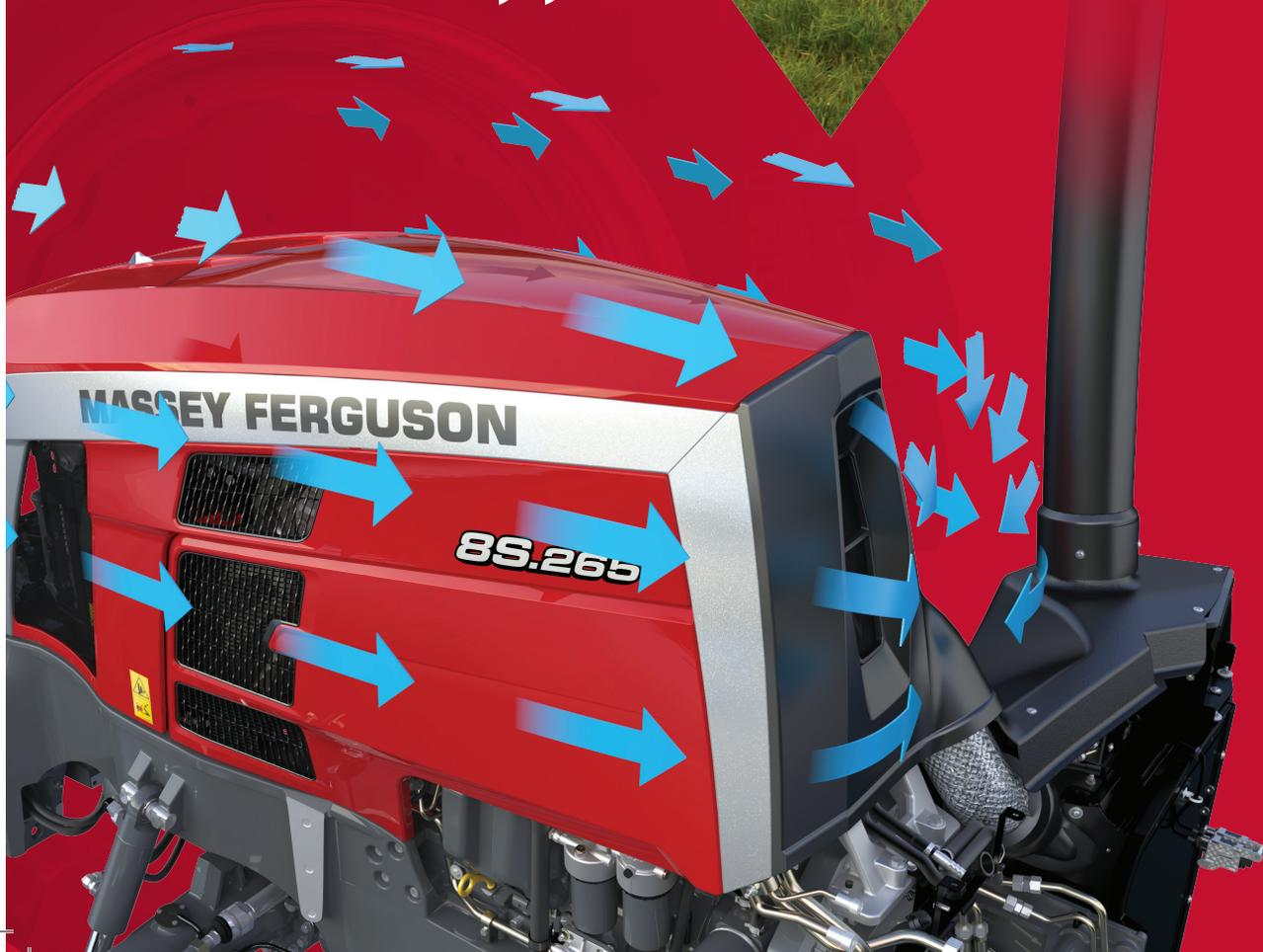

# OUR PAST FUELS OUR **FUTURE**

The new MF 8S Series combines radical design with a practical purpose. The striking “neo-retro” design pays tribute to the brand’s legacy, illustrated by a new interpretation of the iconic MF gray saber stripe on the side and horsehead collar motif on the hood, which dates back to the MF 100 and MF 2000 Series.



OUR CLASSIC DESIGN ...



... REFRESHED FOR TODAY AND BEYOND

**The next level for space, comfort, ergonomics and connectivity**

- ▶ The quietest cab on the market, with a noise level of only 68 dB. It also offers 360° visibility.
- ▶ Cab and front axle suspension improves driving comfort while the new MF vDisplay digital dashboard provides all needed information at a glance. The new armrest offers best-in-class control of all the tractor's operations.

# YOUR MF 8S SERIES AT A GLANCE

The MF 8S Series is a tractor ahead of its time. It outperforms on comfort, connectivity, ease of use, power efficiency, output, low cost of operation and top reliability for fully maximized uptime and the best return on your investment.

**Low cost of operation**

- ▶ Engine efficiency – max power and torque at low engine revs cut fuel consumption by 10% and reduces noise level
- ▶ Automatic valve clearance setting
- ▶ Easy access to daily maintenance
- ▶ AGCO GenuineCare maintenance and service contracts



**Efficient drivelines bring higher productivity and efficiency**

- ▶ Dyna-VT™ stepless transmission offers total operator comfort and optimum fuel efficiency at all times
- ▶ Engine Power Management to deliver more power when it's needed most
- ▶ Perfect engine/transmission combinations provide maximum output and more power efficiency, reducing power loss by up to 26%

WITH SIX MODELS TO CHOOSE FROM, THIS IS ONE OF THE BEST CHOICES THAT YOU WILL MAKE.

	MF 8S.205	MF 8S.225	MF 8S.245	MF 8S.265	MF 8S.285	8S.305
Engine	AGCO Power™ — All-in-One technology					
Engine capacity	6 cylinder, 7.4 liter					
Transmission	Dyna-VT					
*Rated engine HP @ 1,950 rpm	190	210	230	250	270	290
*Max. engine HP @ 1,850 rpm	205	225	245	265	285	305
Rated PTO HP	150	170	190	205	220	240

\*ISO TR 14396



**Straightforward, smart, sustainable farming technologies. New Datatronic 5 and optional Fieldstar 5 terminal provide the latest user-friendly precision farming package**

- ▶ 9-inch touch-screen terminal created to provide a more intuitive and precise farming experience
- ▶ New MF Guide solutions provide economy by reducing overlaps
- ▶ MF Section and Rate Control allows you to adjust the application rate on the go, while automatically minimizing overlap, skips and wasted product
- ▶ MF TaskDoc® creates and sends securely detailed records of jobs to the office and preferred partners through the cloud
- ▶ MF Connect telemetry enables remote and near real-time monitoring and decision making, improving efficiency and maximizing uptime

**Ability to work faster with the most demanding implements**

Up to five spool valves to the rear and three to the front, including front linkage, and Power Beyond installation, plus a high lift capacity hitch. The hydraulic system offers the ability to work faster with the widest implements while increasing versatility.



MADE FOR  
**COMFORT**





# THE MF 8S SERIES CAB

## A NEW ERA FOR COMFORT, VISIBILITY AND CONTROL

The Massey Ferguson cab has been renowned for excellence since the earliest days of modern tractor design. With the MF Protect-U design, the MF 8S Series moves that legacy a step forward. We recognize the value of a comfortable cab environment when days get long and hectic, so we worked hard to give you a productive place that blends roominess, comfort, visibility, quiet, ease of use, connectivity and quality.

Why? Because a more productive operator creates better profit for their business.



121.1 ft.<sup>3</sup>

Of space for you and a passenger



VISIBILITY  
71 ft.<sup>2</sup>  
OF GLASS SURFACE

With tilted windshield to provide  
increased control and ease of operation



68 dB

The quietest cab on the market today  
for reducing stress and fatigue

# MADE FOR DETAILS

WHEN IT COMES TO MAKING A DIFFERENCE TO YOUR WORKDAY, THE LITTLE DETAILS MATTER.

## EASY AND SECURE ACCESS

Large, wide door; steps; rails; and tiltable steering column provide best-in-class accessibility to the cab.

## THE NEW MF VDISPLAY

The MF 8S Series' easy-to-read digital dashboard can be personalized.



**ALWAYS CONNECTED** — Two USB ports and adjustable phone and tablet holder available through AGCO Parts.



The optional Bluetooth RDS/MP3 radio allows you to make hands-free calls, listen to your favorite podcast or practice some cab karaoke.



## POWER CONTROL LEVER

Exclusive and simple, the unique Massey Ferguson Power Control lever provides straightforward three-in-one operation.



### YOU CAN:

- shuttle between forward  / reverse 
- shift speeds and ranges: up  and down 
- de-clutch 
- select neutral

LEAVING YOUR RIGHT HAND FREE  
TO OPERATE A LOADER OR ANY  
IMPLEMENT HYDRAULICS.

# MADE FOR **COMFORT**

**SUN SHADE** — Up to four sun blinds, along with the tilted front windscreen and the large roof, provide shade for total protection.



**FRONT WIPER**  
With the MF Protect-U cab design, 72% coverage of the windscreen is achieved. Lateral wiper option is also available.



**SIDE MIRRORS** feature an adjustable top and lower section offering the best view during transport and reducing blind spots. Options include electric de-icing and electronically adjustable mirrors.



The **16 LED LIGHTS OPTION** transforms night into day. This includes comfort light delay at the end of the day with automatic work light shutoff.



**CAB SUSPENSION** brings extra comfort. Two types available: mechanical and active mechanical.



The **ACTIVE MECHANICAL CAB SUSPENSION** uses silent block bushes and spring-assisted shock absorbers, providing optimum damping forces for all driving situations. It is adjustable, allowing you to set the firmness of ride.

## ALWAYS FRESH

**EFFICIENT AUTOMATIC AIR CONDITIONING** is available and supplied through 14 automotive-style outlets located all around the operator for perfect air distribution ...



... automatic management is available via the **Datatronic 5** on the Deluxe models ...



... and controls are easily accessible on the armrest.



Keep your lunch and beverages fresh with the handy cooler located under your passenger seat.



## WORK DOESN'T HAVE TO FEEL LIKE A CHORE.

We have several seat options to choose from depending on the model you choose. Each of them provides outstanding comfort.



### DELUXE MODELS

Automatic air-suspended swivel seat, heated, with lateral damping



### OPTIONAL ON DELUXE MODELS

Semi-leather automatic air-suspended swivel seat, ventilated, two levels of heating, lateral damping and dual-motion backrest, with Dynamic Damping System

# MADE FOR **PRODUCTIVITY**

The Deluxe cab configuration is a combination of high-spec versatility and refinement. It's designed for large-scale operators looking for advanced features that will ensure cost-effective benefits for their business, especially in terms of automation, precision ag and connectivity.

The Deluxe armrest offers numerous benefits to operating multiple frequently used controls. Deluxe also adds the Datatronic 5 as standard. Use this 9-inch touch-screen terminal to manage tractor functions, simplify implement operations through ISOBUS, and take advantage of MF precision ag.

When you use the Deluxe package, you'll be able to operate the most technologically advanced and demanding implements with optimum efficiency, which adds up to increased profitability.



### EXCLUSIVE ELECTRO HYDRAULIC JOYSTICK

- A Lift front linkage or rear valve control +
- B Lower front linkage or rear valve control -
- C Front or rear valve control +
- D Front or rear valve control -

## DELUXE VERSION

THE ULTIMATE EXPRESSION OF PRODUCTIVITY AND INNOVATION

### COMFORT

#### STANDARD

- QuadLink front axle suspension
- Mechanical active cab suspension
- Automatic air conditioning
- Mirrors with electric de-icing and adjustment
- Automatic air-suspended swivel seat, heated, lateral dampening

### EFFICIENCY

- Dyna-VT transmission — 31 mph standard
- All controls in the ergonomic armrest with MultiPad lever
- Closed center 54 GPM (205 l/min) hydraulics
- Four electrical spool valves with electrical joystick and fingertips

### CONNECTIVITY

- Datatronic 5 9-in. touch-screen with new interface — all tractor function & technology
- MF Guide guidance ready from factory
- MF Connect telemetry with five-year subscription
- MF TaskDoc recording all jobs' data
- ISOBUS

#### OPTION

- 16 LED working lights
- Rear camera

- Closed center 54 GPM (205 l/min) ECO hydraulics
- 10,580-lb Cat. 3 front linkage
- 1,000 rpm front PTO
- Up to eight electrical spool valves fully configurable and customizable on the Deluxe armrest

- MF Guide system with Advanced guidelines
- MF Section & Rate Control
- MF TaskDoc Pro
- Fieldstar 5 terminal

MultiPad lever

Driving mode



Datatronic 5  
9 in. terminal

PTO engagement

3 fingertip spool valves

Lights and air conditioning controls

Linkage depth adjustment

Phone & radio control

Traction control

Hand throttle



# MADE FOR PERFORMANCE

THE PURE EXPRESSION OF  
POWER EFFICIENCY

The new MF 8S Series teamed up with the most mature engine SCR technology on the market, the undisputed sustainable leader in heavy-duty farming operations delivering class-leading power and torque, with best-in-class total cost of ownership.

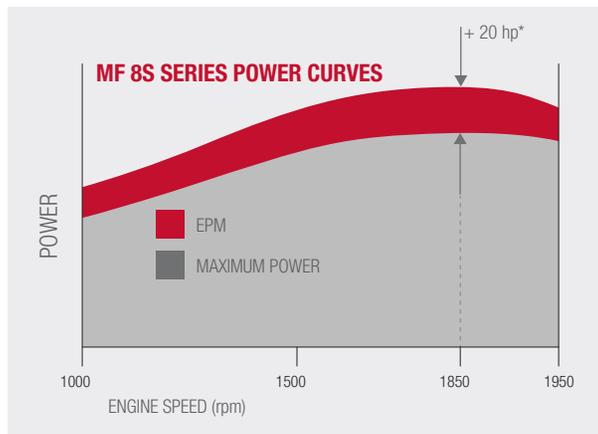
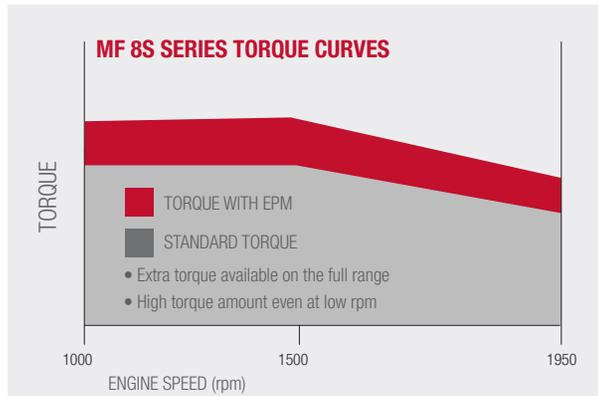

EPM available on the full range  
(not only at max power)  
Constant power between max power  
rpm and max torque rpm



UP TO 12%  
more torque



+5HP  
power max



-40%  
particle reduction

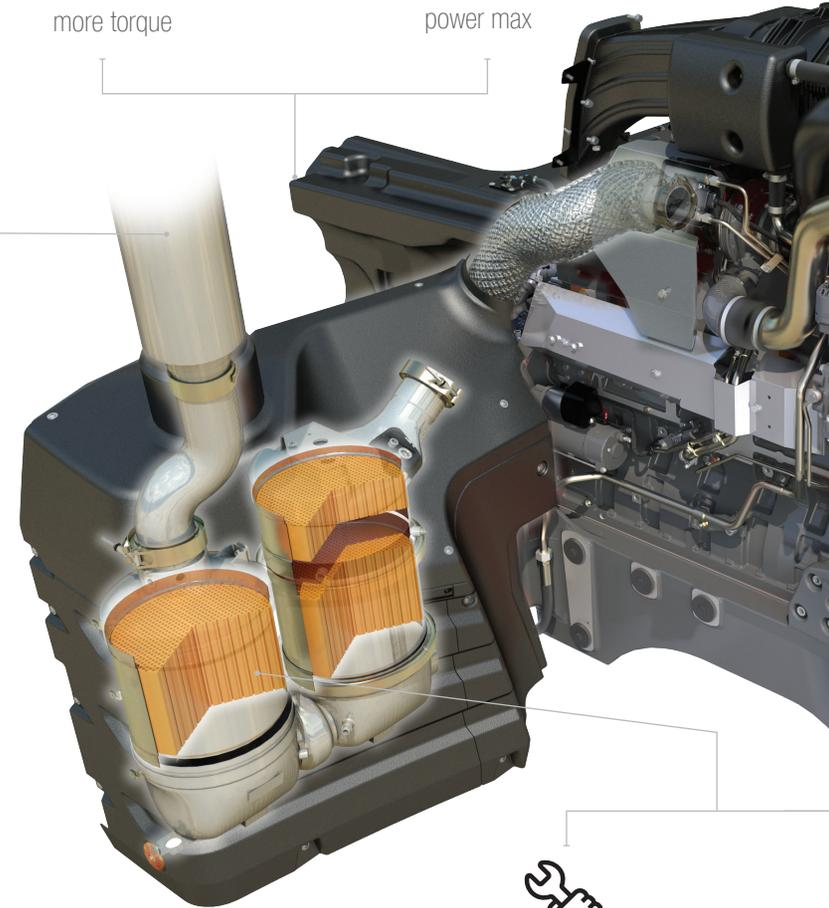

LOW MAINTENANCE  
COSTS



# EFFICIENT SUSTAINABILITY

7.4 L, 6-cylinder AGCO Power engine maximizes the advantages of the most environmentally friendly de-pollution system to improve air quality, mitigate climate change and contribute to a quieter environment for the operator and the neighborhood during working hours.



**+8% POWER** ▶  
with Engine Power Management



**+5%**  
higher productivity



**10%**  
FUEL SAVINGS



**NO COMPROMISE**  
The All-in-One de-pollution system is packed up neatly under the cab for great visibility



**-5.5dB**  
by lower engine revs

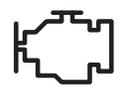

**LOW IDLE**  
Automatic low idle system cuts engine revs to save fuel and reduce noise

## EPM

EPM OFFERS UP TO 20 HP MORE WHEN IT IS MOST NEEDED.

This means your MF 8S Series responds automatically to the load imposed on it and adjusts fueling accordingly to give you extra power. Designed to tackle tough transport and PTO work challenges, advanced electronic engine and transmission management makes more power automatically available under load or at speed.

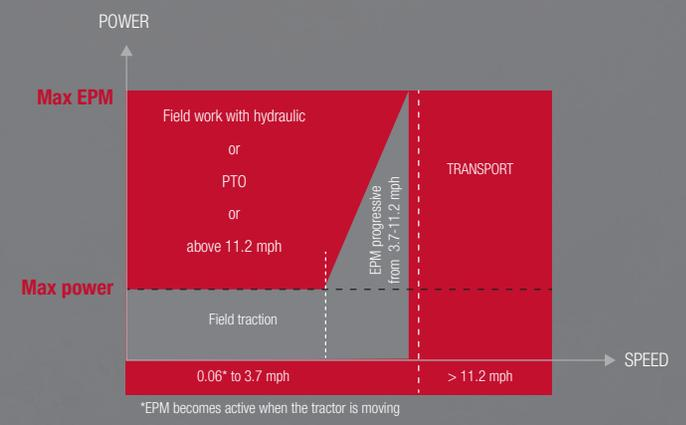

# DYNA-VT

ENGINEERED FOR SUPERIOR  
POWER TRANSFER

The Dyna-VT continuously **variable transmission** provides simple, straightforward operation without sacrificing power to the ground or fuel efficiency. Two speed ranges allow you to optimize torque for any task at hand.

SIMPLE CVT OPERATION.  
**PRECISE SPEED CONTROL.**

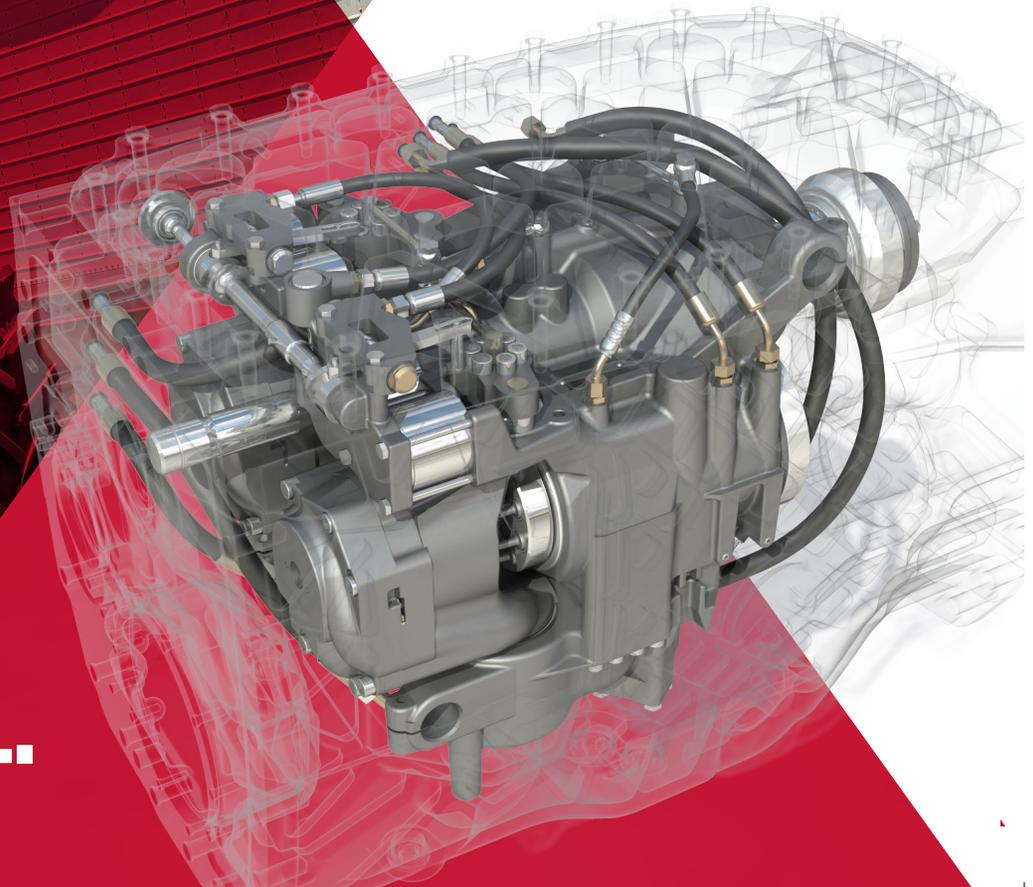

The Dyna-VT works hand in hand with our **Dynamic Tractor Management (DTM)** feature. DTM gives you precision control, allowing you to maintain any speed from .03 to 31 mph and automatically adjusting engine speed to your load.

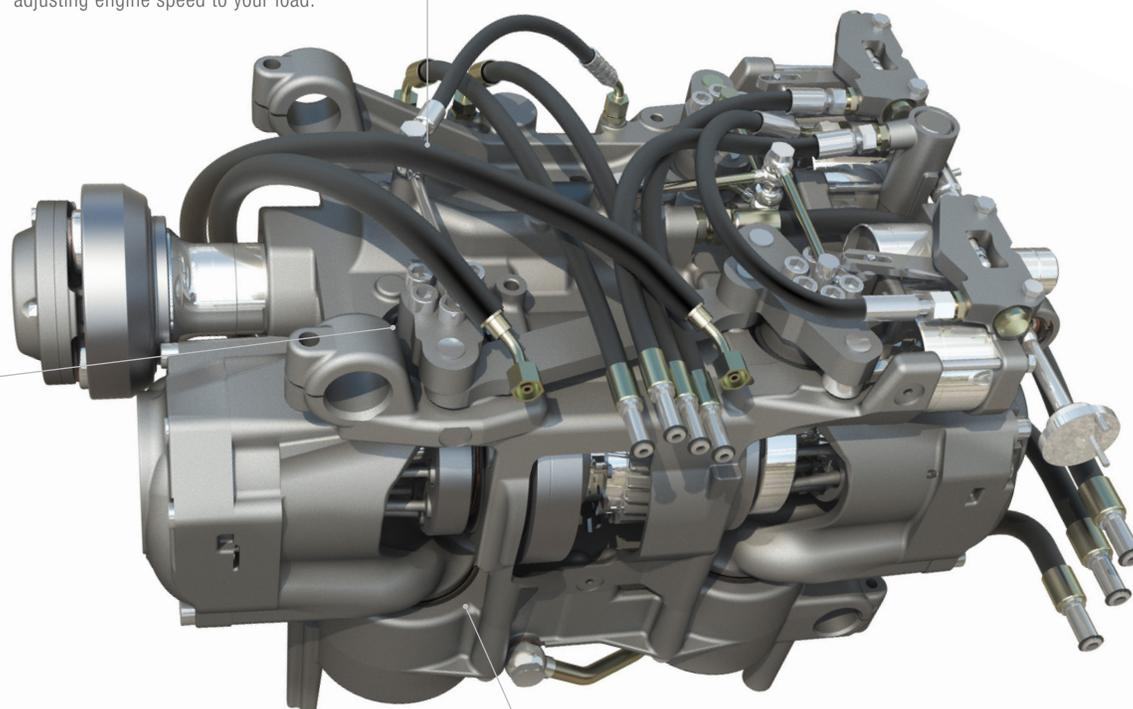

The CVT transmission oil reservoir and the auxiliary hydraulic oil reservoirs are kept separate in the Dyna-VT, eliminating the risk of cross-contamination between them.

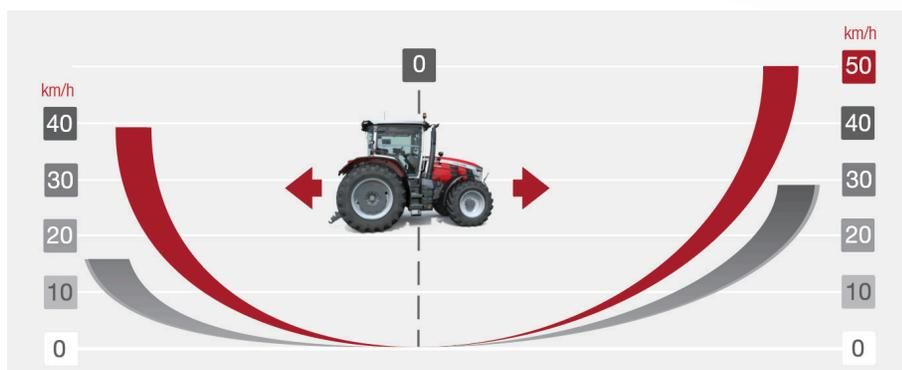

## DYNA-VT TRANSMISSION BENEFITS AT A GLANCE

- ▶ Two speed ranges optimize torque for different applications
- ▶ Lever, pedal and automatic control offer flexibility, allowing you to focus on your tasks
- ▶ Active Stop and turbo clutch features, along with shuttle aggressiveness and pedal aggressiveness adjustments, give you further levels of control
- ▶ Dynamic Tractor Management (DTM) maintains the set travel speed by automatically adjusting the power (engine speed) according to load
- ▶ Switch easily between two different customizable cruise speed settings (C1 and C2)
- ▶ Brake pedal to neutral feature disconnects drive when the brake pedal is pressed

The same two driving modes are available on the entire MF 8S range:

- ▶ Manual mode with the engine rpm management by the pedal and transmission by the lever
- ▶ Automatic mode, in which the operator controls tractor speed with the pedal and/or the lever, the engine and transmission adapt automatically to the speed and ratio

# MADE FOR VERSATILITY & TRACTION

Tractor power means nothing if it cannot be transferred to where it matters: the ground.

With a minimum weight of just 8.7 tons, the MF 8S Series tractors are lighter than others in this class. This allows them to tread lightly for top work and transport, while the strong design also enables them to carry heavy loads or be ballasted up for draft operations.

A wide range of ballast and tire choices, including a large rear wheel diameter of 80.7 inches, ensures that MF 8S Series tractors can be tailored precisely to the tasks that are expected of them, guaranteeing you maximum traction and soil preservation while using a minimum amount of fuel.

That is part of our commitment to help protect the soil and preserve the land for future generations.



## PERFECT WHEELBASE FOR THE PERFECT POWER AND SOIL PRESERVATION

Wheelbase length is 10 feet, offering improved stability with or without a heavy implement, maintaining high levels of traction in the field and increased comfort in transport.

The combination of the wheelbase and the MF 8S Series chassis design means that less ballasting weight is needed, ensuring maximum soil preservation and reduced ground pressure during cultivation, drilling and seeding.



### ▲ **BALLASTING FOR FLEXIBILITY**

To deal with intensive traction work or counter ballast (front or rear), sometimes you need extra weight, so a wide choice of ballasts is available. The MF 8S Series is available from the factory with additional front and rear weights to exactly match your needs.

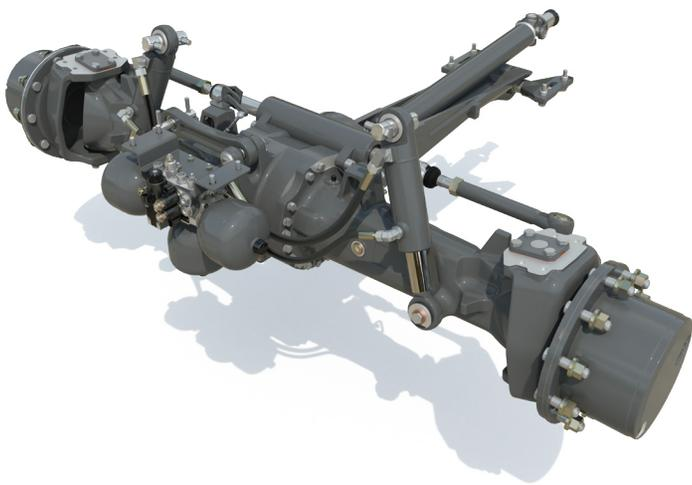

### ◀ **QUADLINK FRONT AXLE SUSPENSION**

Improved comfort for transport applications and greater traction are delivered by a new and innovative front suspension option. The simple design produces superior ride comfort and a wide turning angle, offering the full angle of oscillation while maximizing ground clearance. Completely maintenance-free.

18.7 ft.  
turning radius\*

### ▲ **MANEUVERABILITY**

Experience improved maneuverability for loader operation, in the farm yard and when turning at the headland. The curved design of the chassis and bonnet ensures one of the best turning circles on the market.

▼ **SPEEDSTEER** reduces operator effort and provides faster turns, maximizing your time in the cab. It enables the operator to adjust the steering ratio and select the number of turns of the steering wheel required for a given amount of steering angle turns.

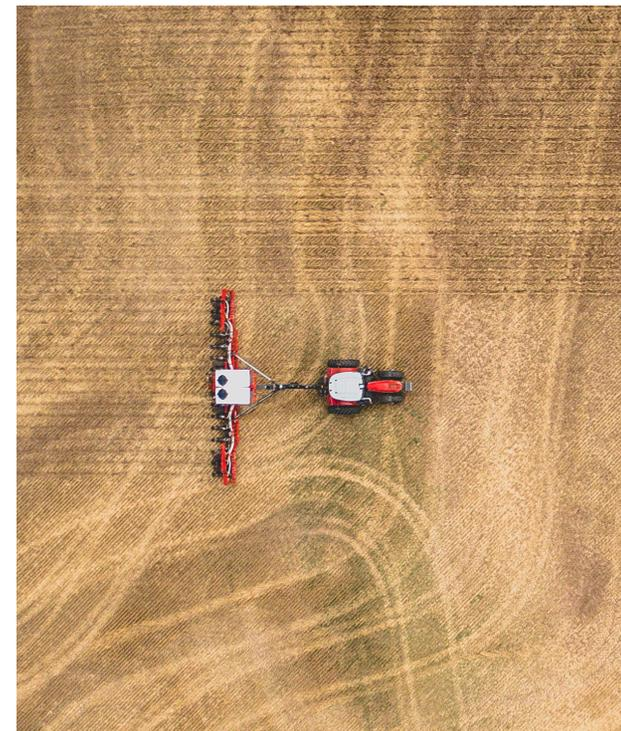

\*Track 76.8 inches with 600/70R30 front tires

# MADE FOR HARD WORK

## UP TO 54 GPM ECO

Hydraulic efficiency is key for the overall performance of the tractor. The MF 8S Series comes standard with 54 GPM. Closed center load-sensing hydraulics and the option of 54 GPM ECO offer you the highest flow at low engine revs to save fuel.



Up to

2

front spool valves  
and free return.



Up to

**\*9,260 lb.**

lift capacity. Heavy-duty integrated front linkage system (IFLS) is available as an option and is designed to match the front suspension.

\*At frame and full stroke



**ISOBUS**  
connector to connect to  
your implements.



**1,000 RPM**

front PTO is available. Combined with the front linkage, this allows a wide range of additional implements to be powered, reducing passes and improving efficiency. You'll benefit from real-time savings, more than doubling output when mowing grass.



## 3 PTO

speeds on Deluxe models: 540 ECO, 1,000 or 1,000 ECO, offering more flexibility, whatever the task. Speeds are achieved at around 1,550 engine rpm, further improving fuel economy and helping to reduce in-cab noise levels.



Up to

## \*16,500 lb.

lift capacity from heavy-duty rear linkage with Ultimate Draft Control. Massey Ferguson's digital ELC system gives the highest standards of draft control with more accurate depth settings and better ground contour following. The result is more weight transfer, better traction, less wheel slip, reduced tire wear and reduced fuel consumption while still maintaining greater output.

# POWER BEYOND

BUILT INTO THE CCLS SPOOL BLOCK IS A POWER BEYOND FACILITY that provides oil flow directly from the pump via additional flow and return pipes, enabling additional remote spool valves to be connected.



Up to

## 5

rear spool valves and free return with decompression lever.

## MADE FOR PRECISION AG & CONNECTIVITY

The new MF 8S Series takes precision ag and connectivity to new heights with the latest Connective Package, which comes standard.

You'll get real-time information and remote service through the new and more intuitive Datatronic 5 interface and the Fieldstar 5 terminal. These allow you to control precision ag features such as: MF Guide, MF Section and Rate Control, as well as data transfer and management through MF TaskDoc and TaskDoc Pro.

“ We run our operations with the very latest technology in order to reduce inputs and develop excellent data management practices. ”





# DATATRONIC 5

Powered by Fuse® precision ag solutions

**FUSE**  
SMART FARMING. SYNCHRONIZED.



**Full tractor function management** and optimization features for transmission, engine and hydraulics. The Dual Control system provides excellent control of semi-mounted plows by automating the furrow entry and exit. At the same time the system adjusts the plow's depth wheel in relation to the rear linkage.



**ISOBUS for total implement control** — ISOBUS allows an implement manufacturer's control system to be displayed on the terminal screen, saving owners and operators time and money, with no need to install additional monitors in the cab. Simply plug the implement lead into the tractor's ISOBUS socket and the system automatically uploads the operating menus and displays on the screen.

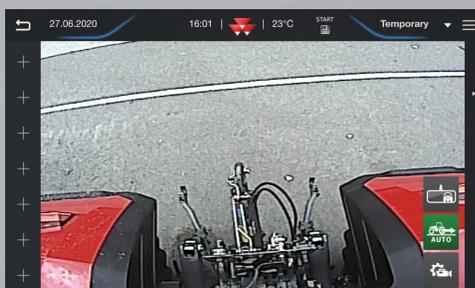

**Video mode** — Pictures from the on-board camera can be displayed on the console screen, allowing operators to monitor complex implements or simply improve efficiency when reversing.



**ISOBUS MultiPad switch assignment** — ISOBUS implements can be controlled directly using the MultiPad lever. Having all controls (tractor and implement) on the same lever is a lot more convenient than using additional displays and levers.



**Headland management settings** — The Datatronic 5 comes as standard with the most intuitive, straightforward and easy-to-use automatic headland management system available in the market. It is designed to save you significant time at headlands, allowing you to concentrate on the operation at hand so that you can maximize outputs with ease.



**Memorize data and settings** — An unlimited number of user setting configurations enable the system to record information during operation on area worked, fuel use, hours worked and much more. All the settings and parameters can be stored by the Datatronic 5 terminal and recalled to find a previous setting.

# MFguide

FUSE SYNCHRO-

## MADE TO KEEP YOU ON TRACK

MF Guide is Massey Ferguson's full featured, hands-free steering system. MF Guide is capable of delivering sub-foot and sub-inch accuracy, increasing the efficiency of your farming operations.

## THE RIGHT RECEIVER FOR THE JOB



NovAtel



Trimble

With TerraStar RTK Assist, MF Guide continues to work at sub-inch level accuracy for up to 20 minutes without a correction signal. RTK Assist Pro offers unlimited RTK assistance, maintaining the highest accuracy for longer RTK correction outages.

The highly accurate and reliable NovAtel® receiver is recommended for optimal performance of Massey Ferguson's MF Guide system. For those wanting to leverage existing Trimble infrastructures on the farm, such as NTRIP for RTK, MF Guide also offers the option of a Trimble receiver. Talk to your local Massey Ferguson dealer or distributor to find out more.

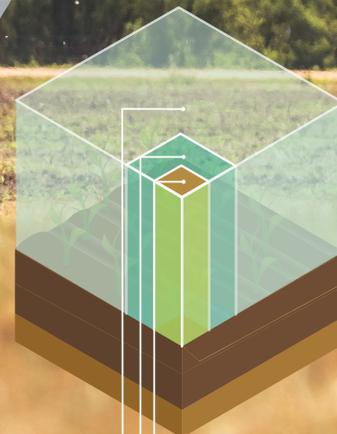

- .8 in.: Novatel/Trimble RTK
- 1.6-5.9 in.: Novatel/Trimble optional correction signals
- 5.9-11.8 in.: Novatel/Trimble Standard





# EASY, FAST SETUP WITH **GO MODE** FUNCTION



... IMPLEMENT ...



... WAYLINE ...

Get going within five minutes, even for first-time users. This allows the operator to begin working with auto-guidance/steering for the first time in three easy steps ...



## KEY BENEFITS **FOR YOU**



**12% FUEL SAVING**  
Guidance systems are proven to save up to 12% fuel in field operations.



**NO OVERLAPS**  
MF Guide virtually eliminates overlaps.



**SAVINGS**  
Using MF Guide helps you save money by reducing overlaps, precision application and increasing efficiency.



**COMFORT**  
Using MF Guide helps to reduce fatigue and stress by guiding you efficiently through your working day.

# MFtask doc

FUSE SYNCHRONISED

Information is power, with accurate data measurement and recording enabling more precision in decision making. The new TaskDoc system has a place in the future of agriculture, helping farmers to become more productive through the knowledge brought by putting precision-measured data at the business owner's fingertips.

With **TaskDoc** all job data can be recorded with minimal effort, documented in the field record and then analyzed — quickly. The data is transferred via USB drive from the Datatronic 5 terminal to the office using the ISOBUS standard TC-BAS. Data on the quantity of seeds and fertilizer applied or the fuel consumption is available immediately after the work is done.

The **TaskDoc Pro** version also enables recording of the GPS position data and data transfer in real-time via mobile. This makes automatic, seamless exchange with ISOXML-capable field management software and mapping possible. The data for the operating inputs that have been used are transferred and can also be monitored through the Datatronic 5 terminal while working.

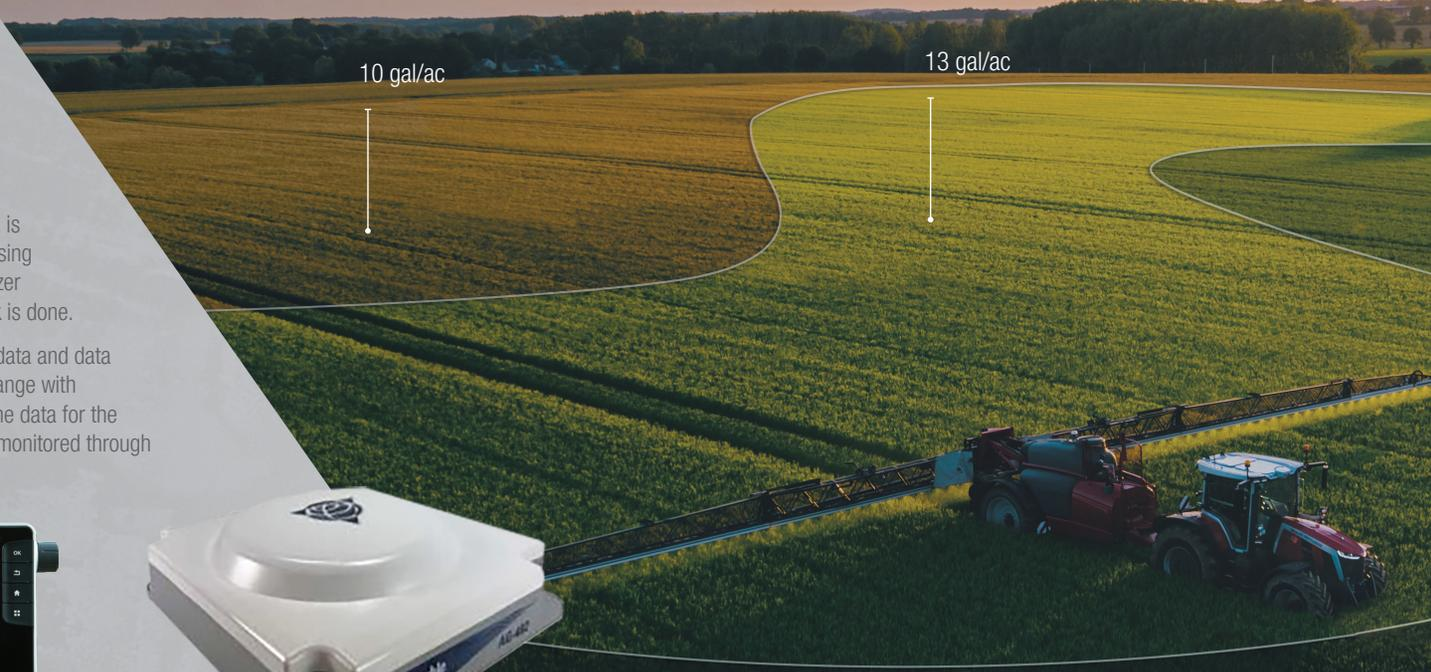

## AGRO LINK

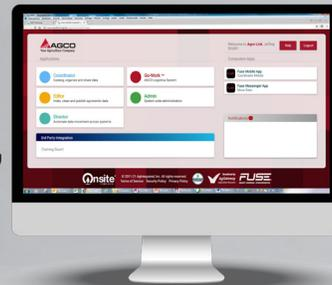

## MFsection control

FUSE SYNCHRONISED

MF Section Control is the new precision farming solution from Massey Ferguson, featuring management of up to 36 sections and five products simultaneously.



This universal data exchange platform lets you connect machinery and your Farm Management Information System (FMIS), regardless of vendor or manufacturer. You can also determine who to exchange data with, and to what extent. Agro Link is your ticket to the digitalization of agriculture, enabling you to retain control of your data.

## PARTS & SERVICE

# IT'S ALL ABOUT A LIFETIME OF SUPPORT

Buying, owning and maintaining equipment can be complex. That's why ensuring you have support and peace of mind is always an important consideration. With Massey Ferguson, you can count on personalized, responsive support from our network of dealers.

With Massey Ferguson, there's no cut-off time for Parts and Service, meaning we're available to you throughout the lifetime of your machine.

There's a pride and responsibility built into every piece of equipment we sell, and we make it our mission to keep your machine running smoothly, every single time you turn the key.

Ask your dealer about AGCO Protection, an extended warranty program that prolongs your coverage and safeguards against the cost of sudden breakdowns.

AGCO replacement parts are made to the same high standards as those used on the assembly line, so your AGCO® equipment will stay running like new. Talk to your dealer, or shop at [parts.agcocorp.com](http://parts.agcocorp.com) to find the AGCO Genuine Parts you need.

Focus on your operation, not on scheduling maintenance. With AGCO GenuineCare plans, your service intervals are predetermined. You'll avoid downtime and be able to better plan your costs thanks to transparent pricing, bundles and discounts.



16 gal/ac

## MFrate control

FUSE SYNCHRONISED

### Variable application with variable rate control (VRC)

Data transfer with TaskDoc Pro now permits variable rate application, based on the needs of the soil or plants, and therefore saves operating inputs. The individual requirements for seeds, fertilizer and pesticides are shown on application maps. They are then called up during operation and automatically executed. The big advantage: Operating inputs can be defined and planned with the aid of the field database and then applied with utmost precision. For example, you can tailor chemical or fertilizer application in areas as required, lowering input cost and further enhancing yields.

14 gal/ac

## TECHNICAL SPECIFICATIONS

<b>ENGINE</b>		<b>MF 8S.205</b>	<b>MF 8S.225</b>	<b>MF 8S.245</b>	<b>MF 8S.265</b>	<b>8S.285</b>	<b>8S.305</b>
Engine Type		AGCO Power					
No. of cylinders / No. of valves / Capacity	No. / No. / L	6 / 4 / 7.4					
Bore / Stroke	mm / mm	108 / 134					
Aspiration		Turbo with electrical wastegate and intercooler					
Injection type		Common rail					
Fan type		Vistronic					
*Rated HP	HP PS (kW)	190 (142)	210 (157)	230 (172)	250 (186)	270 (201)	290 (216)
Rated PTO HP (SAE)	HP (kW)	150 (112)	170 (127)	190 (142)	205 (153)	220 (164)	240 (179)
Engine rpm at rated HP	rpm	1,950					
*Maximum HP	HP PS (kW)	205 (151)	225 (165)	245 (180)	265 (195)	285 (210)	305 (225)
Engine rpm at maximum HP	rpm	1,500	1,550			1,850	
*Maximum power with EPM	HP PS (kW)	225 (165)	245 (180)	265 (195)	285 (210)	305 (225)	—
Fuel tank capacity	gal	132.1					
DEF tank capacity	gal	11.4					
Service interval	hours	600					
<b>DYNA-VT TRANSMISSION</b>							
Type		Stepless, continuously variable transmission with Dynamic Tractor Management (DTM)					
Field speed range	mph	.018 - 17 mph forward and .018 - 23 mph reverse					
Road speed range	mph	.018 - 31 mph forward and .018 - 23 mph reverse 25 mph Eco at 1,400 rpm - 31 mph Eco at 1,550 rpm					

\*ISO 14396  
Depending on market legislation

Every effort has been made to ensure that the information contained in this publication is as accurate and current as possible. However, inaccuracies, errors or omissions may occur and details of the specifications may be changed at any time without notice. Therefore, all specifications should be confirmed with your Massey Ferguson dealer or distributor prior to any purchase.

		MF 8S.205	MF 8S.225	MF 8S.245	MF 8S.265	8S.285	8S.305
<b>Rear Linkage and Hydraulics</b>							
Lower links type	CAT				Cat. 3		
Maximum lift capacity, at link end	lbs.				22,046		
Hydraulic type & max flow - Option 1					Closed center load-sensing 54 gal/min. @ 2,050 rpm		
Hydraulic type & max flow - Option 2					Closed center load-sensing Eco 54 gal/min. @ 1,650 rpm		
Maximum pressure	psi				2,900		
Maximum no. of rear spool valves					5		
<b>Power Take-Off (Rear)</b>							
<b>Engine speed</b>							
540 ECO / 1,000 / 1,000 ECO	rpm				1,499 / 1,903 / 1,528		
Shaft diameter					1 3/8" 6 & 21 splines 1 3/4" 20 splines		
<b>Front linkage and Front Power Take-Off</b>							
Maximum lift capacity, at frame & full stroke	lbs.				9,260		
Maximum no. of front spool valves					2		
Engine speed at 1,000 front PTO speed	rpm				1,920		
<b>Wheels and Tires (Full range available. Please consult your dealer)</b>							
Front		420 / 90R30 R1W			420 / 85R34 R1W		
Rear		480 / 80R46 R1W Duals			480 / 80R50 R1W Duals		
<b>Weights (May vary depending on configuration. Please consult your dealer)</b>							
Average minimum weight with no ballast, no accessories	lbs.				19,180		
Maximum gross vehicle weight*	lbs.				35,273		

## DIMENSIONS

		MF 8S (all models)
A Wheelbase	in.	120.1
B Overall length from front linkage to rear linkage arms	in.	211.6
C Height at center of rear axle to the top of MF Connect antennas	in.	94.1
D Total height	in.	133.5





**AGCO  
FINANCE**

**APPLY  
ONLINE**  
FOR FINANCING

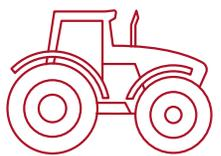

*APPLY NOW FOR PRE-APPROVAL\**  
[www.masseyferguson.com](http://www.masseyferguson.com)



or scan the QR code to get started.



\*Currently only available for individual applicants. Subject to credit review and approval and other terms and conditions. All financing is in AGCO Finance LLC's sole discretion. ©2022 AGCO Corporation. Massey Ferguson is a worldwide brand of AGCO Corporation. AGCO and Massey Ferguson are trademarks of AGCO. All rights reserved. | MF22B011FC



**MASSEY FERGUSON**

BORN TO **FARM**